



FITTING INSTRUCTIONS

Part #: 0000-8W-L42

2014 MAZDA3 4-Door & 5-Door

Paint Protection Film: Front Upgrade Kit

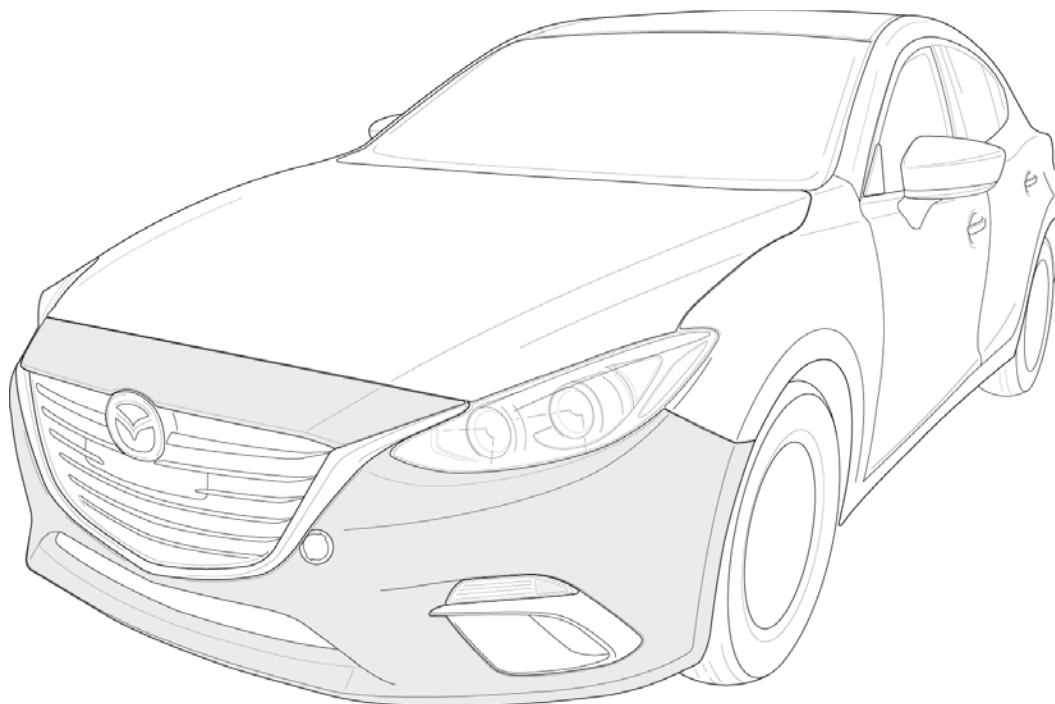

Kit Contents

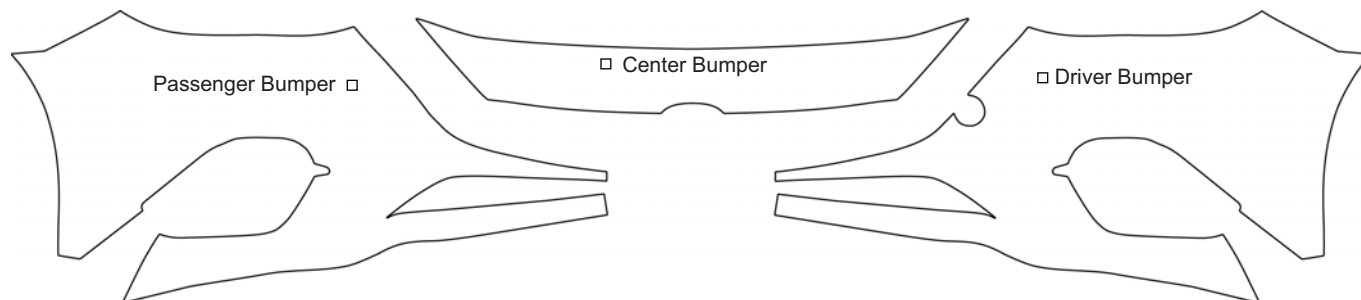

Tools

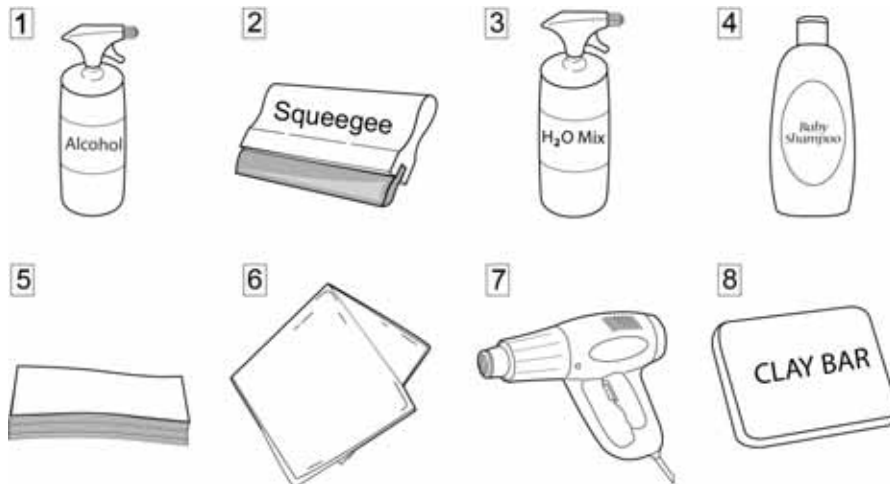

1. 70% Isopropyl Alcohol
2. Squeegee
3. H₂O Mix
4. Baby Shampoo
5. Wipes
6. Microfiber Towels

Optional Tools:

7. Heat Gun
8. Clay Bar
9. Supplementary Tools

Installation Solution Mixture Guide

Baby Shampoo & Water Solution

The solution mixture is extremely crucial for a proper installation. The mixture will vary depending on temperature. Follow the instructions and see the chart for guidance.

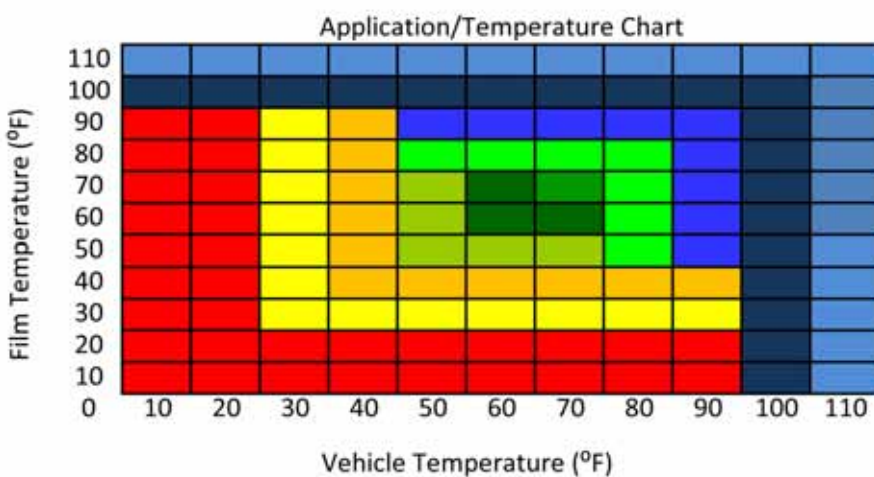

What you'll need:

1. (2) 32 oz Spray Bottles
2. Water (Distilled Preferred)
3. 70% Isopropyl Alcohol

Mixing Installation Solutions:

1. Fill up 1st spray bottle with water (distilled preferred).
2. Add 4 drops of Unscented Johnson's Baby Shampoo
3. Shake Well
4. 2nd spray bottle will be used for Isopropyl Alcohol. This accelerates the adhesive to be more aggressive. It will be 60% water and 40% alcohol. It is used for tacking areas and holding edges from lifting.

- Install Not Recommended at temp. Cool down car or film by spraying cold water on vehicle surface.
- Install Not Recommended at temp. Cool down car or film by spraying cold water on vehicle surface.
- Good Install Conditions. Mix 6 drops of shampoo to 32 oz of water (distilled preferred), compensate for heat.
- Excellent Install Conditions. Mix 5 drops of shampoo to 32 oz of water (distilled preferred).
- Ideal Install Conditions. Mix 4 drops of shampoo (aprox 1/4 in size) to 32oz of water (distilled preferred).
- Excellent Install Conditions. Mix 4 drops of shampoo (aprox 1/4 in size) to 32oz of water (distilled preferred).
- Good Install Conditions. Decrease amount of soap, add 2-4 oz of 70% isopropyl alcohol to mix.
- Install Not Recommended at this temperature. Warm up vehicle's paint and film before applying.
- Install Not Recommended at this temp. Warm up vehicle's paint and film before applying.
- Install Not Recommended at this temp. Warm up vehicle's paint and film before applying.

Vehicle Cleaning Prep

- 1 Always before applying PPF film be sure to clean and prep the surface using an alcohol based cleaner or degreaser if needed. Additional prep may include using a clay bar to clean very small stubborn debris.

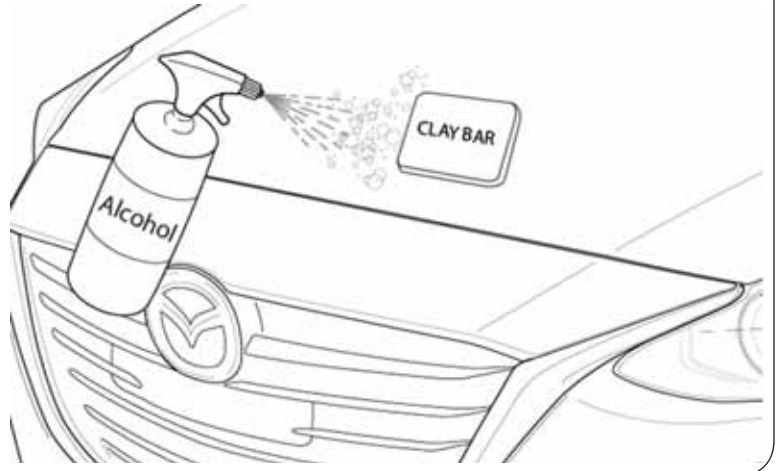

Center Bumper Application

- 1 Wet the film, finger tips, and vehicle surface. Then position film on the center bumper.

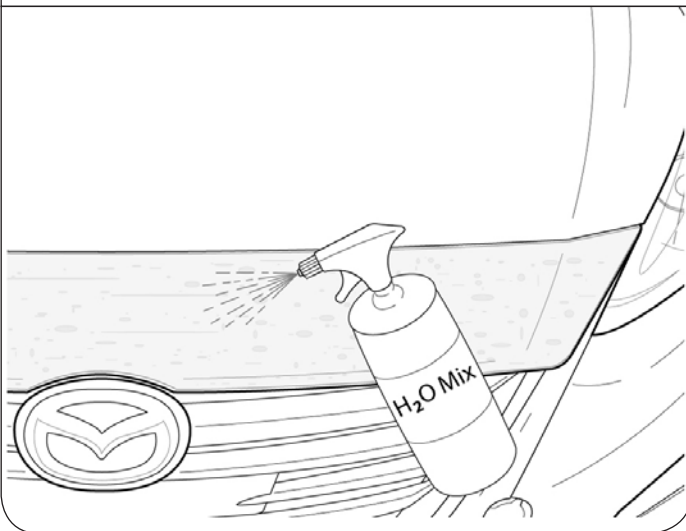

- 2 Locate center and lift film, spray alcohol to create a tack then squeegee down area.

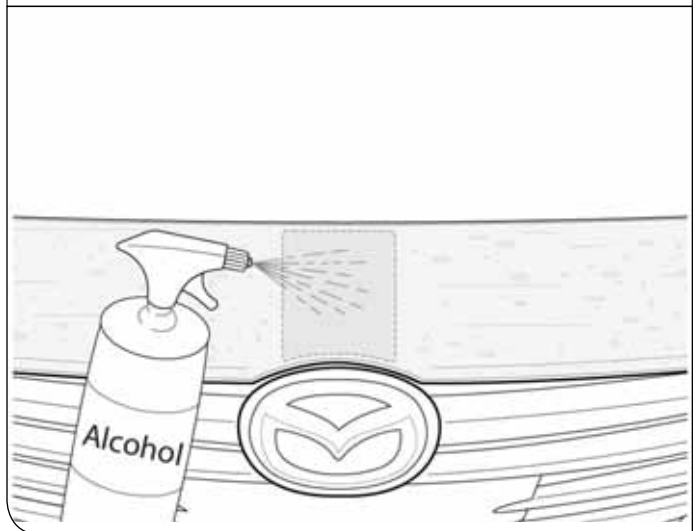

Center Bumper Continued →

- 3 Select a side and spray alcohol as shown, this includes the lower edge above the grill. Fasten sections down paying close attention to corners.

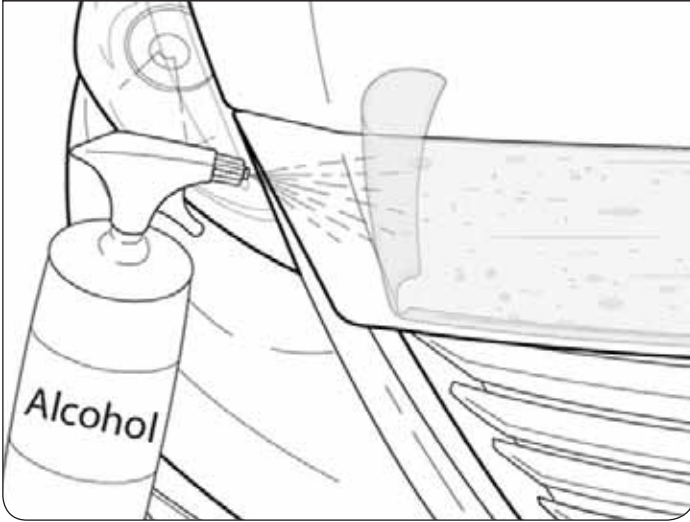

- 4 The lip of film above grill should fold down. Proceed to squeegee sprayed areas into place.

REPEAT STEPS ON REVERSE SIDE.

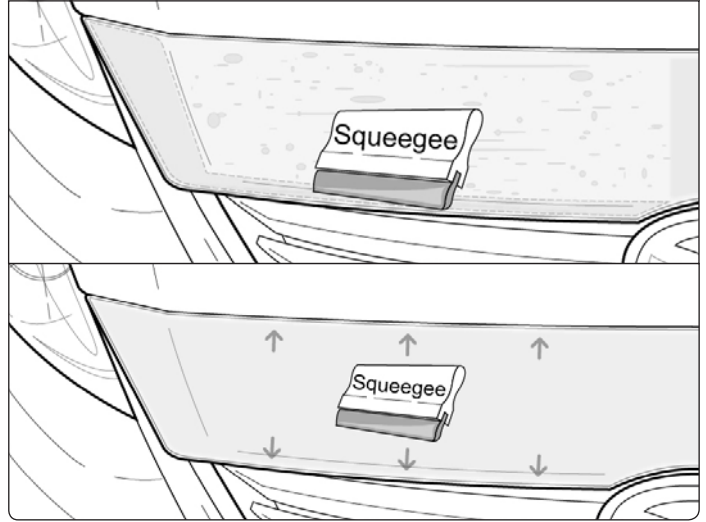

Bumper Application

- 1 Spray the bumper's surface, wetting the film piece thoroughly, then proceed to position piece on bumper.

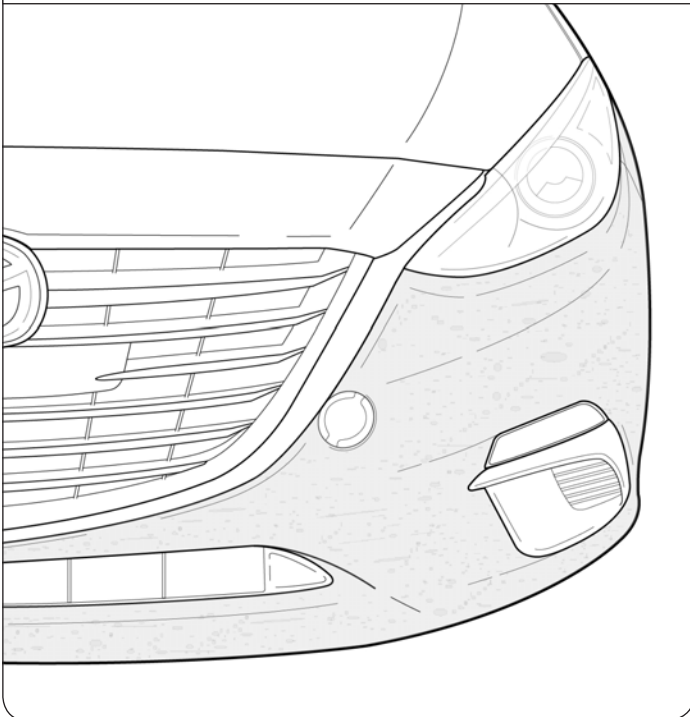

- 2 **Drivers Side:**
Fold back the areas around the tow hook and spray alcohol.

- * **Passenger Side:**
Lift and spray alcohol where the tow hook would be on the passenger side.



Bumper Continued →

3

Squeegee down sprayed areas to form alcohol tack.

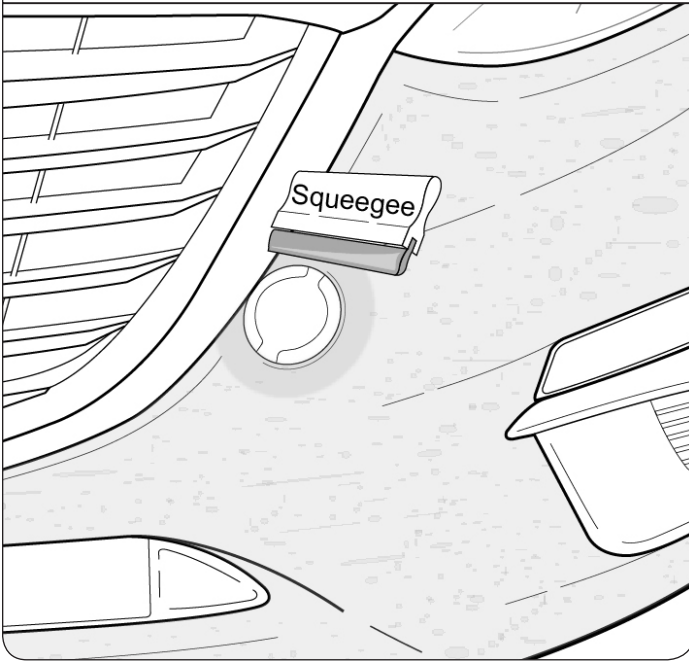

4

Spread squeegee movements outward in areas shown.

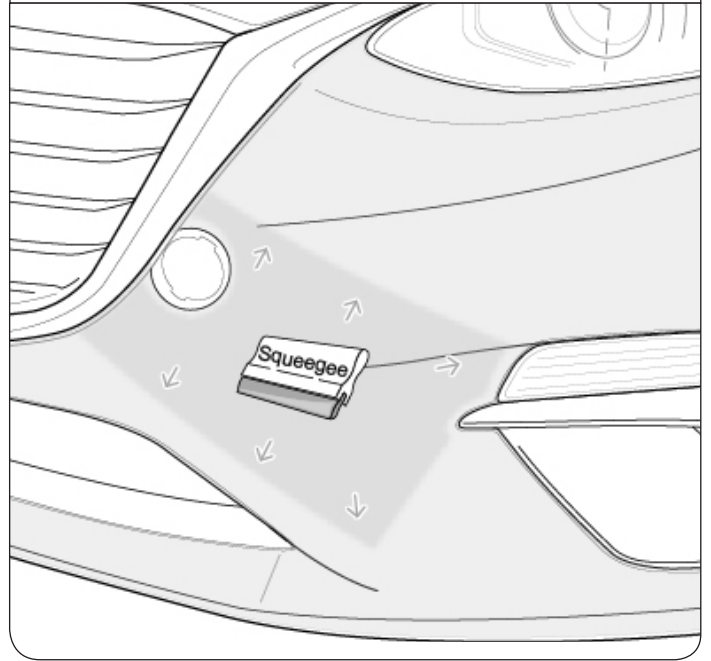

5

Lift back the film near the tire and spray with soap solution. Re-position film making sure edges align and prepare for squeegee.

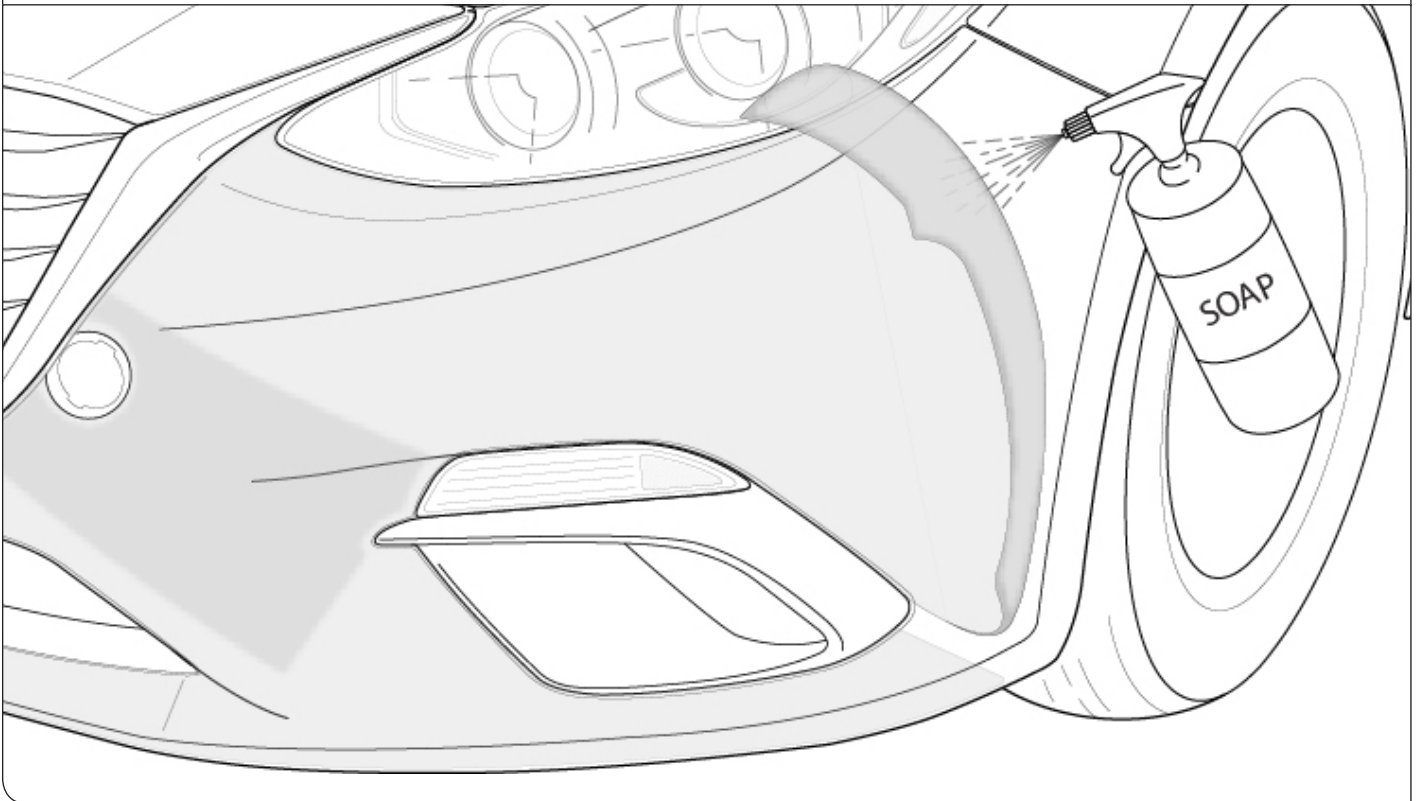

Bumper Continued →

- 6 Align edges within tolerance, and squeegee areas as shown. Conform piece to the shape of bumper with squeegee.

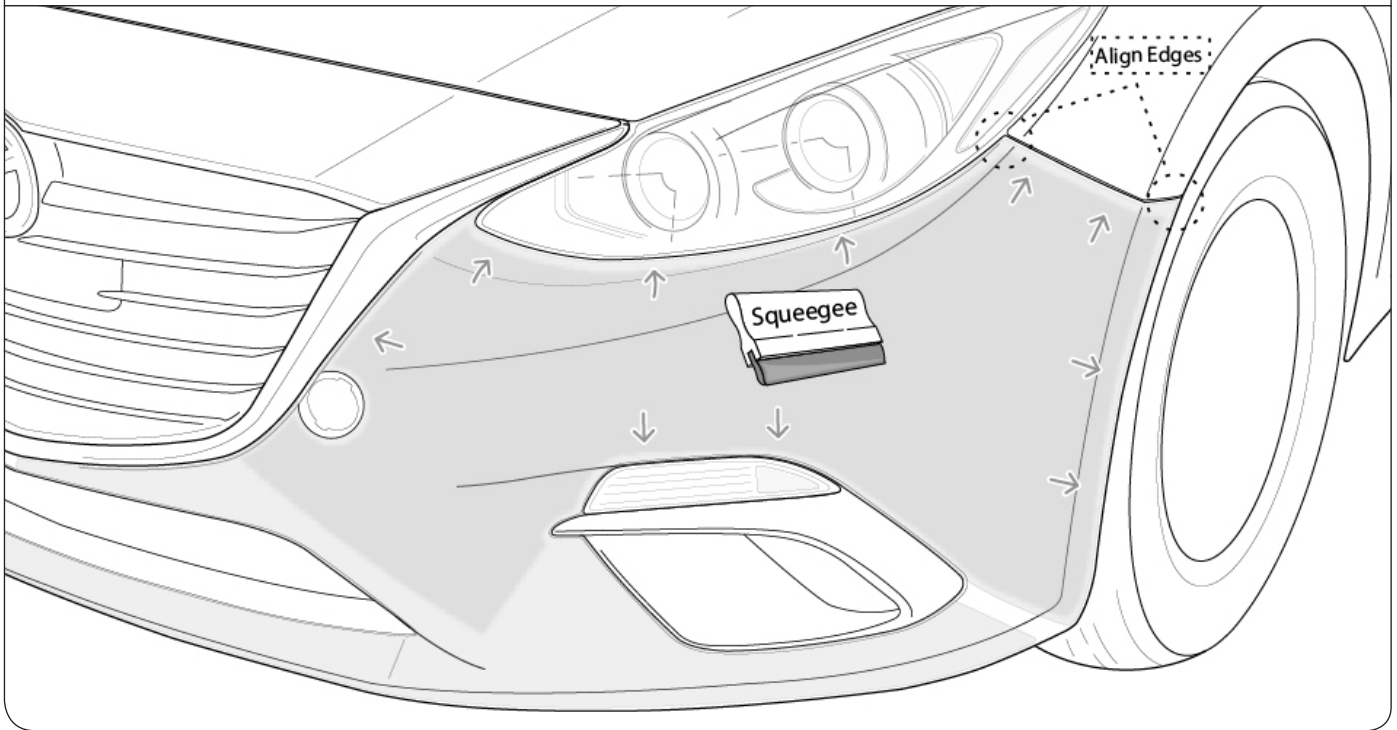

- 7 Squeegee around the bottom areas of the bumper and if necessary re-wet film. Connect the bottom sections of the film together. Using the palm of your hand, lightly stretch the film to seam together.

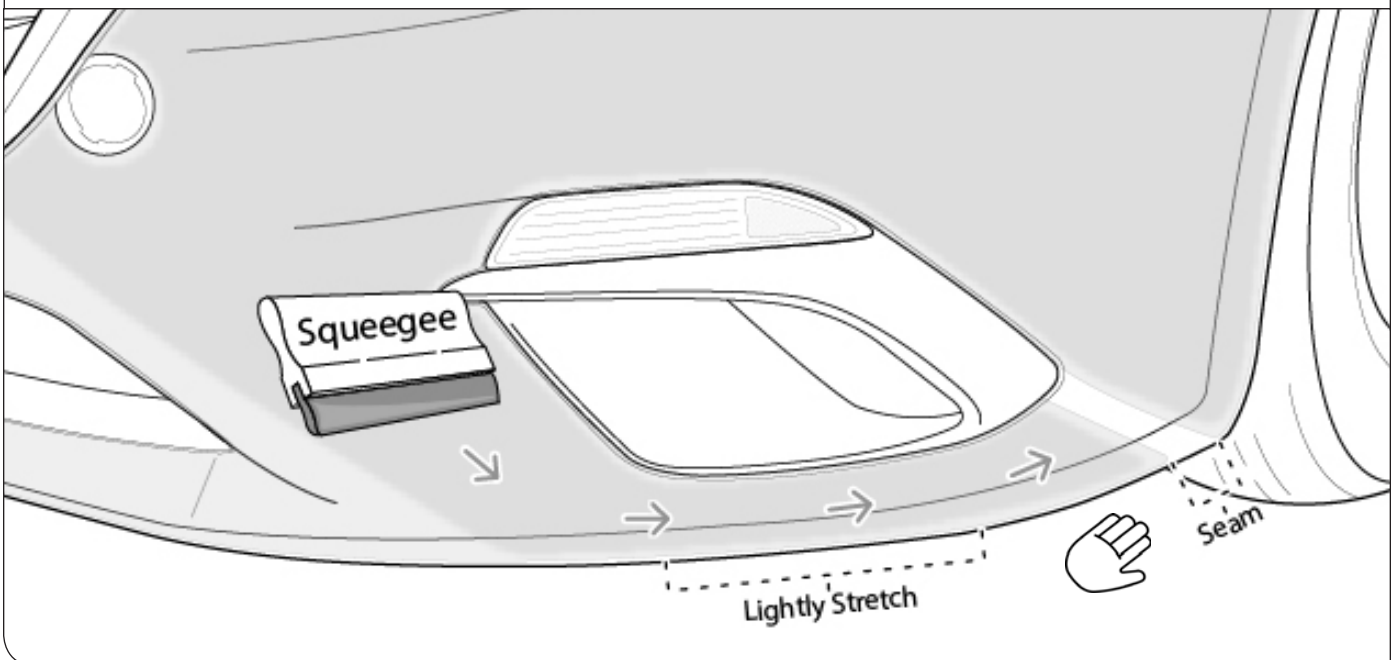

Bumper Continued →

8

Finally, squeegee the areas below the grill, be sure to watch the edges to make sure film aligns correctly to bumper.

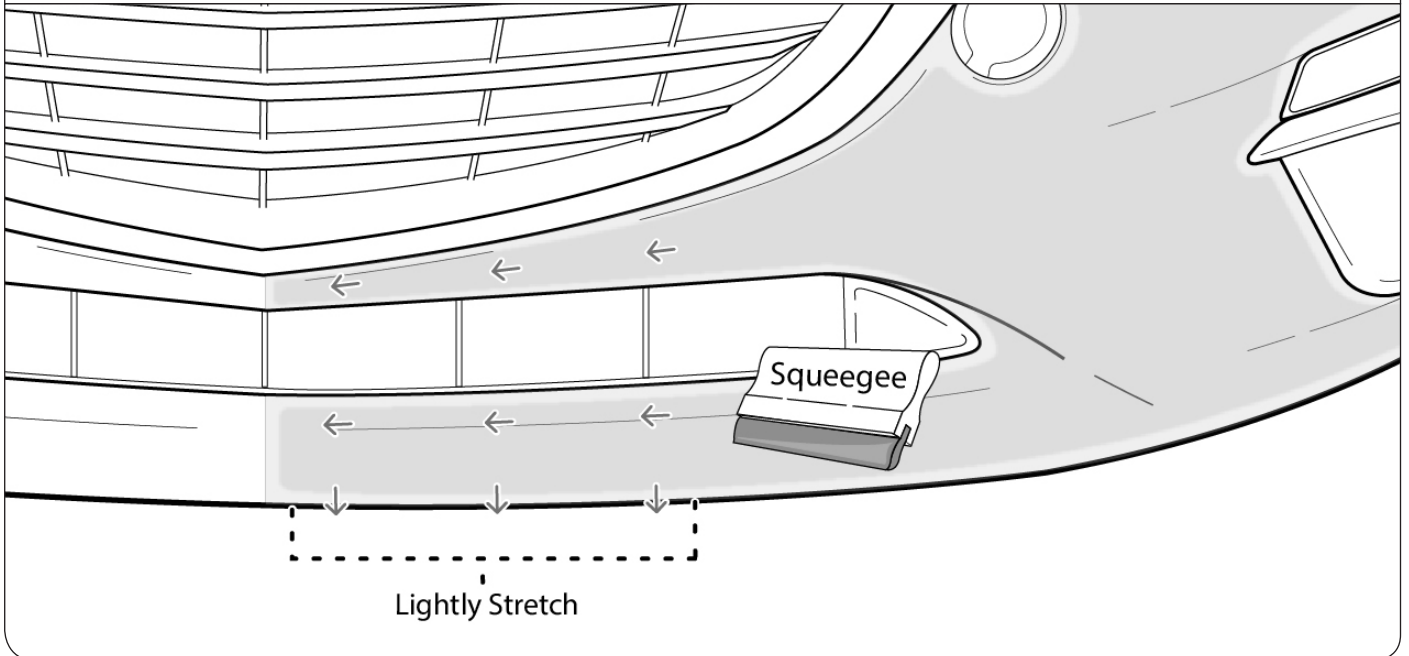

Finishing Steps

After all parts of kit are installed (bumper and center bumper). Dry kit pieces using a heatgun.

ALL STEPS COMPLETED!

